

# USER'S GUIDE



Save complete model and serial number identification for your dryer. This is located on a data plate on the lower center of the door opening. Record these numbers below for easy access.

Model Number

-----

Serial Number

-----

Date of Purchase















\_\_\_\_\_

For additional questions, please contact us:

Maytag Appliances Sales Company  
1-800-688-9900 USA  
1-800-688-2002 CANADA  
1-800-688-2080 USA TTY (for deaf,  
hearing impaired or speech impaired)  
Mon.-Fri., 8am-8pm Eastern Time  
Internet: <http://www.maytag.com>

**NOTE:** In our continuing effort to improve the quality of our appliances, it may be necessary to make changes to the appliance without revising this guide.

**IMPORTANT:** Keep this guide and the sales receipt in a safe place for future reference. Proof of original purchase date is needed for warranty service.

-  **SAFETY** ..... Pages 1-2
-  **DRYER EXHAUST TIPS** ..... Page 3
-  **OPERATING TIPS** ..... Page 4
-  **CONTROLS** ..... Pages 5-6
-  **DRYING WITH DRYEL** ..... Page 7
-  **CARE & CLEANING** ..... Page 8
-  **REPLACING DRUM LIGHT** ..... Page 8
-  **REVERSING THE DOOR** ..... Page 8
-  **SPECIAL LAUNDRY TIPS** ..... Page 9
-  **DRYER ACCESSORIES** ..... Page 9
-  **BEFORE YOU CALL** ..... Page 10
-  **WARRANTY** ..... Page 11
-  **GUIDE DE L'UTILISATEUR** ..... Page 12
-  **GUÍA DEL USUARIO** ..... Page 24

**IMPORTANT:** For service and warranty information, see page 11.

# IMPORTANT SAFETY INSTRUCTIONS

## **WARNING:**

For your safety, the information in this manual must be followed to minimize the risk of fire or explosion or to prevent property damage, personal injury or death.

**-Do not store or use gasoline or other flammable vapors and liquids in the vicinity of this or any other appliance.**

### **-WHAT TO DO IF YOU SMELL GAS**

- Do not try to light any appliance.
- Do not touch any electrical switch.
- Do not use any phone in your building.
- Clear the room, building or area of all occupants.
- Immediately call your gas supplier from a neighbor's phone. Follow the gas supplier's instructions.
- If you cannot reach your gas supplier, call the fire department.

**Installation and service must be performed by a qualified installer, service agency or the gas supplier.**

**WARNING — To reduce the risk of fire, electric shock or injury to persons when using your appliance, follow basic precautions, including the following:**

1. Read all instructions before using the appliance.
2. To avoid the possibility of fire or explosion:
  - a. Do not dry items that have been previously cleaned in, washed in, soaked in, or spotted with gasoline, dry-cleaning solvents, other flammable or explosive substances as they give off vapors that could ignite or explode. Any material on which you have used a cleaning solvent, or which is saturated with flammable liquids or solids, should not be placed in the dryer, until all traces of these flammable liquids or solids and their fumes have been removed. There are many highly flammable items used in homes, such as: acetone, denatured alcohol, gasoline, kerosene, some liquid household cleaners, some spot removers, turpentine, waxes and wax removers.
  - b. Items containing foam rubber (may be labeled latex foam) or similarly textured rubber-like materials must not be dried on a heat setting. Foam rubber materials when heated, can under certain circumstances produce fire by spontaneous combustion.
3. Do not allow children to play on or in the appliance. Close supervision of children is necessary when the appliance is used near children.
4. Before the appliance is removed from service or discarded, remove the door to the drying compartment.
5. Do not reach into the appliance if the drum is moving.
6. Do not install or store this appliance where it will be exposed to the weather.
7. Do not tamper with controls.
8. Do not repair or replace any part of the appliance or attempt any servicing unless specifically recommended in published user-repair instructions that you understand and have the skills to carry out.
9. Do not use fabric softeners or products to eliminate static unless recommended for dryer use by the manufacturer of the fabric softener or product.
10. Clean the lint screen before or after each load.
11. Keep the area around the exhaust opening and surrounding areas free from lint accumulation, dust and dirt.
12. The interior of the dryer and exhaust duct should be cleaned periodically by qualified service personnel.
13. This appliance must be properly grounded. Never plug the appliance cord into a receptacle which is not grounded adequately and in accordance with local and national codes. See installation instructions for grounding this appliance.
14. Do not sit on top of the clothes dryer.

**SAVE THESE INSTRUCTIONS FOR FUTURE REFERENCE**

## **WARNING:**

Do not place into your dryer items that have been spotted or soaked with vegetable oil or cooking oil. Even after being washed, these items may contain significant amounts of these oils. The remaining oil can ignite spontaneously. The potential for spontaneous ignition increases when the items containing vegetable oil or cooking oil are exposed to heat. Heat sources, such as your clothes dryer, can warm these items, allowing an oxidation reaction in the oil to occur. Oxidation creates heat. If this heat cannot escape, the items can become hot enough to catch fire. Piling, stacking or storing these kinds of items may prevent heat from escaping and can create a fire hazard.

All washed and unwashed fabrics that contain vegetable oil or cooking oil can be dangerous. Washing these items in hot water with extra detergent will reduce, but will not eliminate, the hazard. Always use the "cool down" cycle for these items to reduce the items' temperature. Never remove these items from the clothes dryer hot or interrupt the drying cycle until the items have run through the "cool down" cycle. Never pile or stack these items when they are hot.

## **SAFETY NOTICE & WARNING**

The California Safe Drinking Water and Toxic Enforcement Act of 1986 (Proposition 65) requires the Governor of California to publish a list of substances known to the State of California to cause cancer or reproductive harm, and requires businesses to warn customers of potential exposures to such substances.

Users of this appliance are hereby warned that the burning of gas can result in low-level exposure to some of the listed substances, including benzene, formaldehyde and soot, due primarily to the incomplete combustion of natural gas or liquid petroleum (LP) fuels. Exhaust ducts should be kept free of obstructions and properly exhausted dryers will minimize exposure.

# DRYER EXHAUST TIPS

**WARNING** — Plastic or nonmetal flexible duct presents a potential fire hazard.

## DO

*Read the installation instructions and the user's guide.*

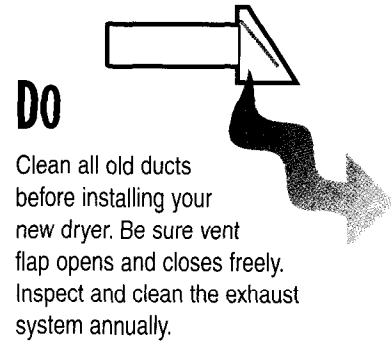
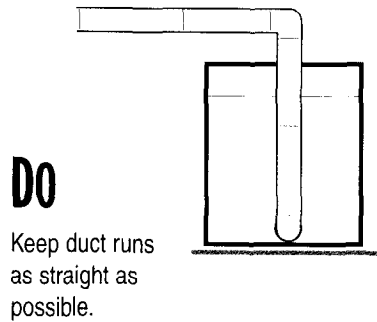
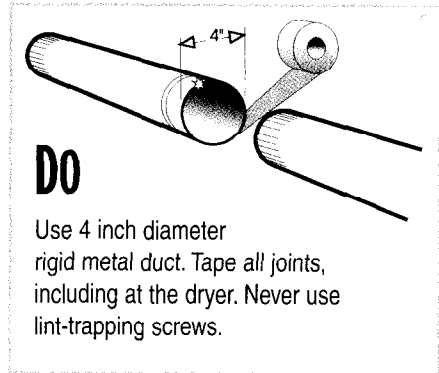
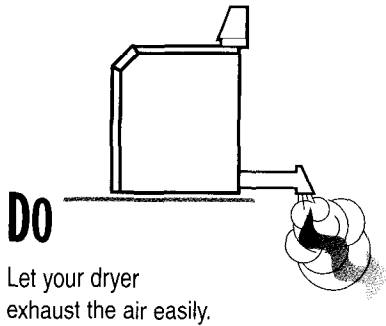

## DON'T

*Let a poor exhaust system cause slow drying.*

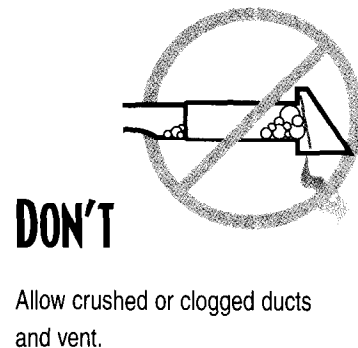
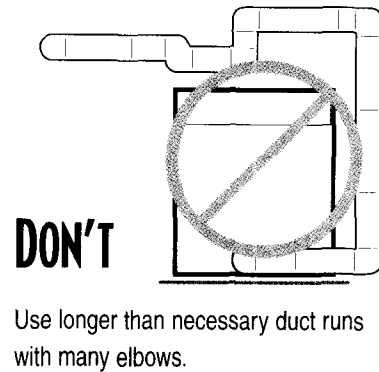

# OPERATING TIPS

## CLEAN THE LINT FILTER

- After each load.
- To shorten drying time.
- To operate more efficiently.

### NOTE:

Do not operate the dryer without the lint filter in place.

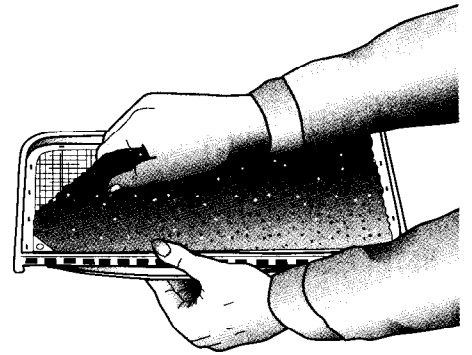

## LOAD THE DRYER PROPERLY

- By placing only one wash load in the dryer at a time.
- Avoid very small loads or mixing heavyweight and lightweight clothes.
- When only one or two articles need drying, add a few similar items to improve tumbling and drying efficiency.
- When drying large, bulky items such as a blanket or comforter, it may be necessary to reposition the load during the cycle to ensure even drying.

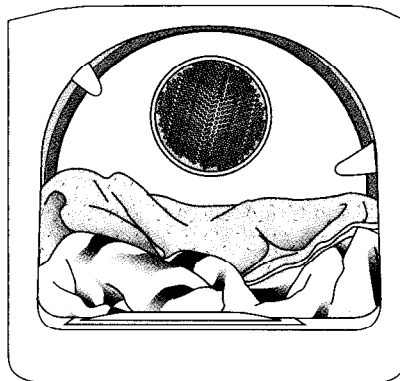

## ADD A FABRIC SOFTENER SHEET (IF DESIRED)

- After loading the dryer.
- To control static cling.
- Before the load becomes warm. This helps prevent greasy-looking softener stains.
- And remove any used softener sheets from the dryer to prevent greasy-looking softener stains.

## CHECK THE MOISTURE MONITOR

Indicator lights in the moisture monitor will display when an IntelliDry cycle is in operation. The top light will blink on and off. As loads dry, there will be longer pauses between each blink. No lights will display during Time Dry or Air Fluff.

The bottom light in the monitor will remain on until the cool down portion of the cycle starts. During cool down the dryer continues to tumble the load in unheated air to help minimize wrinkling.

### MOISTURE MONITOR

MORE

LESS



**NOTE:** The top monitor light may not blink when small loads of heavy, bulky items are dried, such as rugs or sweaters.

# CONTROLS AT A GLANCE

## STEP 1 SELECT CYCLE

**INTELLIDRY WRINKLE FREE FABRICS WITH PRESS CARE** automatically senses the moisture in the load and shuts off when the selected dryness level is reached. It minimizes wrinkles in synthetic fabrics such as acrylic, nylon, polyester or blends by providing an unheated cool-down period at the end of the cycle. Simply set the control to the desired dryness level (MORE DRY – LESS DRY). The line between MORE DRY and LESS DRY is the initial preferred setting for the majority of loads.

**INTELLIDRY REGULAR** automatically senses the moisture in the load and shuts off when the selected dryness level is reached. This cycle is designed for loads such as towels, underwear, t-shirts, jeans, etc. Set the control to the desired dryness level (MORE DRY – LESS DRY). The line between MORE DRY and LESS DRY is the initial preferred setting for the majority of loads.

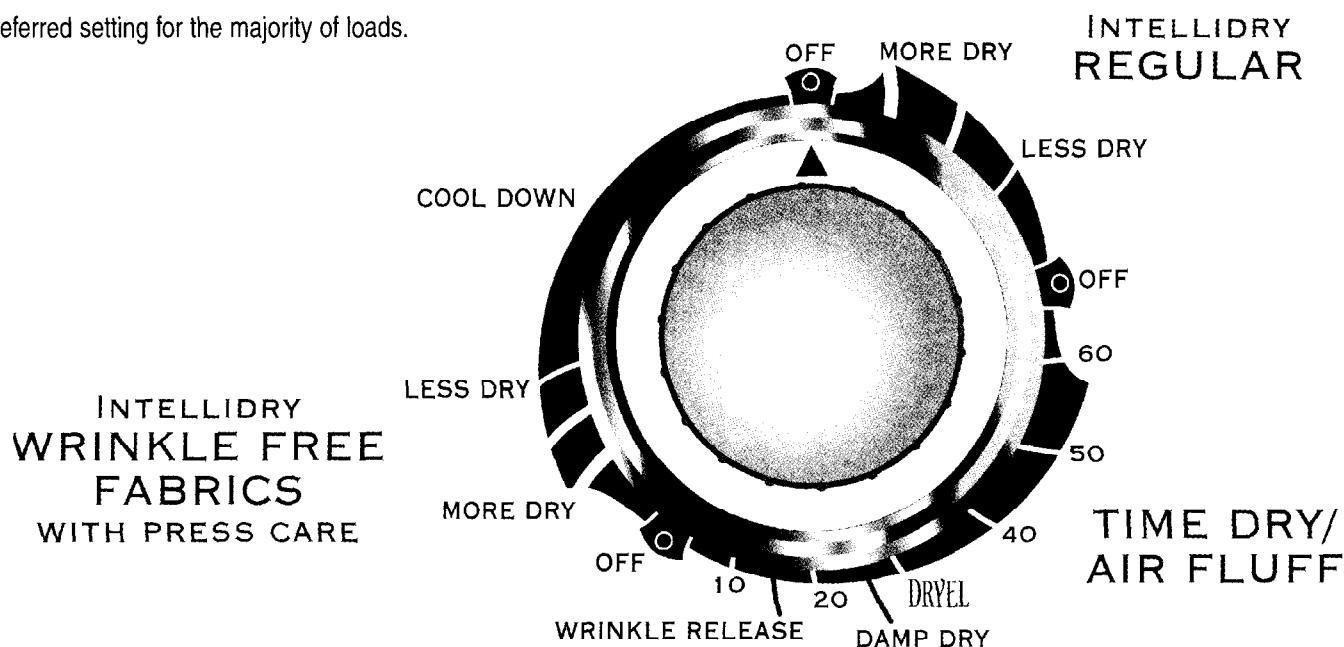

**WRINKLE RELEASE** will release wrinkles from items that are clean and dry but slightly wrinkled, such as from a crowded closet, packed suitcase or from sitting in the dryer too long after the end of the cycle. It provides 10 minutes of heated tumbling and 5 minutes of cool down tumbling without heat.

**DAMP DRY** is designed to “partially” dry items. It provides approximately 20 minutes of heated tumbling and 5 minutes of cool down tumbling without heat.

**DRYEL FABRIC CARE** is designed for use on dry clean only fabrics in combination with Dryel Dry Clean Only Fabric Care product. Placing the control dial arrow at the DRYEL line will provide the optimal amount of time needed to properly use Dryel. (For more information on using the Dryel cycle, see page 7.)

**TIME DRY/AIR FLUFF** may be selected for any load if the IntelliDry sensor system is not used. Set the control to the desired number of minutes and choose the appropriate drying temperature for the load.

**NOTE:** The dial can be turned in either direction to select a cycle. Once started, the dial will not advance at a specific rate during the IntelliDry cycles. At first the dial may not advance at all. Toward the end of the cycle (when the load begins to dry) the dial will advance at a more regular rate and much more quickly. This is normal operation.

## TEMPERATURE

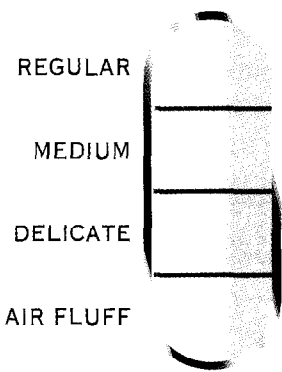

### STEP 2 SELECT TEMPERATURE

**REGULAR** – for sturdy cottons or those labeled “Tumble Dry”.

**MEDIUM** – for permanent press, synthetics, lightweight cottons or items labeled “Tumble Dry Medium”.

**DELICATE** – for heat sensitive items labeled “Tumble Dry Low” or “Tumble Dry Warm”.

**AIR FLUFF** – tumbles without heat. Used for sensitive loads or items needing freshening.

### STEP 3 PRESS START

Push this button to start the dryer. The dryer door must be shut for the dryer to operate. If the door is opened during the cycle, the start button must be pushed again to resume the cycle once the door is closed.

**End of Cycle Chime** – Shortly before the cycle is complete, an audible chime will sound. During the cool down portion of the Wrinkle Free Fabrics cycle, the audible chime will sound intermittently.

## START

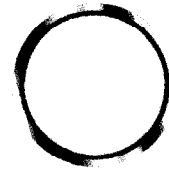

# USING YOUR DRYER WITH DRYEL

## Setting the Controls for Dryel Fabric Care:

**STEP 1** Set the temperature for Regular heat.  
DO NOT select Air Fluff.

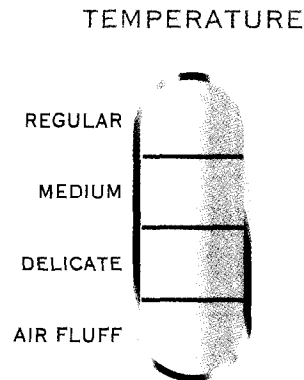

**STEP 2** Set the control dial at the Dryel line.

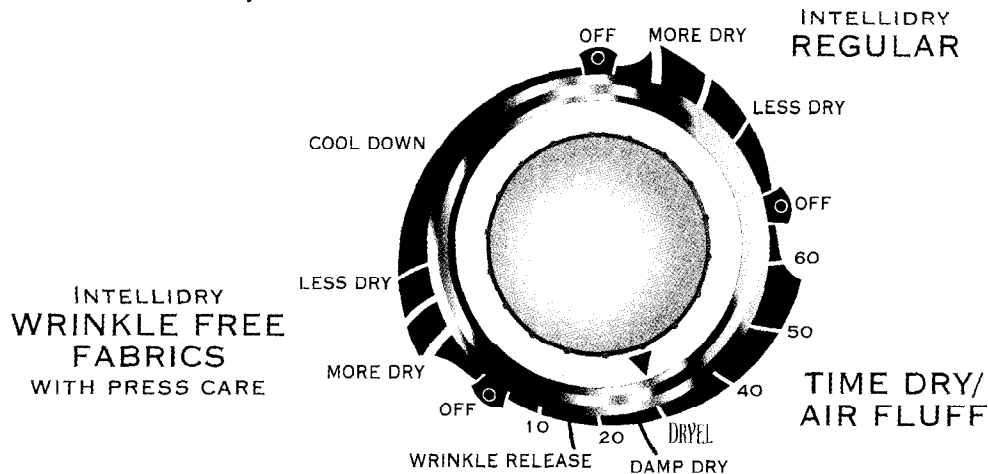

**STEP 3** Press Start Button

### For Best Performance:

- Refer to the Dryel instructions for proper use.
- Items in the bag must tumble. Place no more than 3 to 4 items in the bag at one time.
- Do not mix colors or fabrics when using Dryel.
- Immediately at the end of the cycle, remove garments from the Dryel bag. Hang the garments while still warm and slightly damp to minimize wrinkles.

Use **ONLY** the Dryel fabric care product in your dryer.

**DO NOT** use and place any flammable substance or solvent in the dryer including but not limited to: Energine, Goddard's, lighter fluid, WD-40 and vegetable oil.



# CARE AND CLEANING

**Control Panel** – clean with a soft, damp cloth. Do not use abrasive substances.

**Tumbler** – remove any stains such as crayon, ink pen or fabric dye (from new items such as towels or jeans) with an all-purpose cleaner. Then tumble old towels or rags to remove any excess

stain or cleaning substance. Once these steps are done, stains may still be visible, but should not transfer to subsequent loads.

**Cabinet** – wipe off any marks with soap and water.

**Dryer Exhaust System** – should be inspected and cleaned once a year to maintain optimum performance. The outside exhaust hood should be cleaned more frequently to ensure proper operation. (Refer to the Installation Instructions for more information.)

## REPLACING THE DRUM LIGHT

Instructions for replacing the bulb:

- 1) Unplug or disconnect the dryer from the electrical power supply.
- 2) Open the door and use a Phillips screwdriver to remove the screw attaching the lens to the tumbler front.
- 3) Remove lens cover by pulling cover toward center of tumbler.
- 4) Rotate bulb counter-clockwise to remove from socket.
- 5) Replace the bulb with a 120 volt, 10 watt maximum candelabra base light bulb.
- 6) Turn the light bulb clockwise into socket.
- 7) Replace lens cover by hooking plastic tabs into tumbler front below the light housing.
- 8) Reinstall the screw into the lens cover screw hole.
- 9) Reconnect dryer to power supply.

## REVERSING THE DOOR

Directions for reversing the dryer door:

- 1) Remove the hinge hole covers and screws.
  - 2) While supporting the door, remove 2 screws in the hinges that secure the hinges to the cabinet.
  - 3) Remove door by lifting slightly at the hinges and pulling the hinge tabs out of the hinge slots.
  - 4) Move the following parts to the opposite side of the door: 2 hinges and 4 hinge screws, 4 door screws, door strike and screw, inner door cover plate and screw.
  - 5) Attach the door to the opposite side of the cabinet using the 2 counter sunk hinge screws. (See below).
  - 6) Replace the hinge hole covers to the opposite side.
- Screw the lower hinge screw in first. This will help to align the door and hinges.

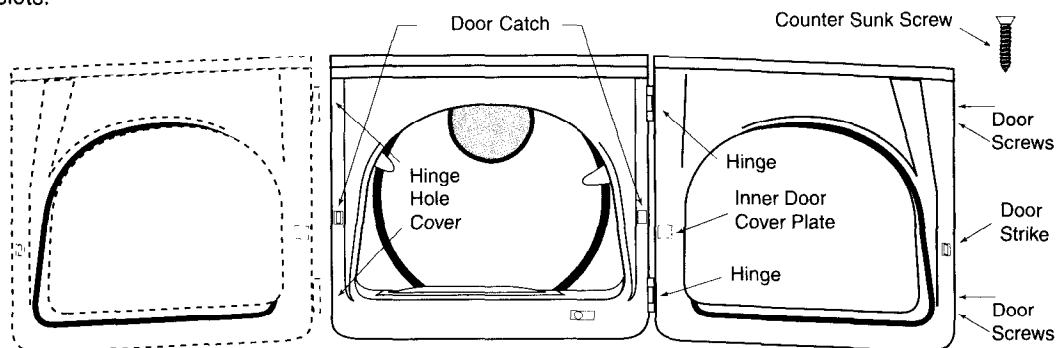

# SPECIAL LAUNDRY TIPS

Please follow the care label or manufacturer's instructions for drying special items. If care label instructions are not available, use the following information as a guide.

## Avoid Dryer Drying...

- Fiberglass Items (curtains, draperies, etc.)
- Vegetable or cooking oil soaked items. (See pg.2)
- Woolens, unless recommended on the label.

---

### Bedspreads & Comforters

- Follow the care label instructions or dry on the Regular cycle.
- Be sure the item is thoroughly dry before using or storing.
- May require repositioning to ensure even drying.

---

### Blankets

- Dry only one blanket at a time for best tumbling action.
- Be sure the item is thoroughly dry before using or storing.

---

### Curtains & Draperies

- Use the Wrinkle Free Fabrics cycle to help minimize wrinkling.
- Dry these in small loads for best results and remove as soon as possible.

---

### Cloth Diapers

- Use the Regular cycle for soft, fluffy diapers.

---

### Down-filled Items

(jackets, sleeping bags, comforters, etc.)

- Use the Regular cycle and a delicate temperature setting.
- Place a clean pair of sneakers in the dryer with the item to fluff the down comforters, etc. Adding a couple of dry towels shortens dry time and absorbs moisture.

---

### Foam Rubber

(rug backs, stuffed toys, certain shoulder pads, etc.)

- DO NOT dry on a heat setting. Use the Time Dry/Air Fluff (no-heat) cycle.
- ⚠ WARNING** – Drying a rubber item with heat may damage it or pose a fire hazard.

---

### Pillows

- Use the Regular cycle.
- Add a couple of dry towels and a pair of clean sneakers to help the tumbling action and to fluff the item.
- DO NOT dryer-dry kapok or foam pillows.

---

### Plastics

(shower curtains, outdoor furniture covers, etc.)

- Use the Time Dry/Air Fluff cycle on a Delicate or Air Fluff temperature depending on the care label instructions.

## DRYER ACCESSORIES

A drying rack is available for items that you don't want to tumble dry; for example, sneakers, washable sweaters, stuffed toys or pillows, etc.

Part No. MAL1000AXX

To order call 1-800-688-8408

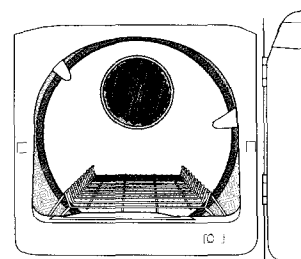

# BEFORE YOU CALL

## CHECK THESE POINTS IF YOUR CLOTHES DRYER...

### DOESN'T RUN

- Be sure the door is latched shut.
- Be sure the power cord is plugged into a live electrical outlet.
- Check the home's circuit breaker and fuses.
- Press the START button again if the door is opened during the cycle.

### DOESN'T HEAT

- Check the home's circuit breaker and fuses.
- Select a heat setting, not air-fluff.
- On a gas dryer, check that the gas supply is on.
- Clean the lint filter and exhaust duct.
- Dryer timer may have moved into the cool-down portion of the cycle.

### DOESN'T DRY

- Check all of the above, plus...
- Be sure the exhaust hood at the outside of the home can open and close freely.
- Check exhaust system for lint build-up. Ducting should be inspected and cleaned annually.
- Use 4" rigid metal exhaust duct.
- Do not overload. 1 Wash load = 1 Dryer load.
- Sort heavy items from lightweight items.
- Large, bulky items like blankets or comforters may require repositioning to ensure even drying.

- Check that the washer is draining properly to extract adequate water from the load.
- Clothes load is too small to tumble properly. Add a few towels.

### IS NOISY

- Check the load for objects such as coins, loose buttons, nails, etc. Remove promptly.
- It is normal to hear the dryer gas valve or heating element cycle on and off during the drying cycle.
- Be sure the dryer is leveled properly as outlined in the installation manual.
- Be sure the rubber feet are installed on the leveling legs.
- A clicking noise may be the timer advancing.
- It is normal for the dryer to hum due to the high velocity of air moving through the dryer drum and exhaust system.

### CONTROL KNOB ADVANCES SLOWLY

- This is normal operation for an IntelliDry cycle, especially at the beginning of the cycle. Once the load begins to dry, the control knob will start to advance. The rate of advancement will be slow at the beginning of the cycle because there is more moisture in the load. As the load becomes more dry, the control knob will advance more quickly.

### DRIES UNEVENLY

- Seams, pockets and other similar heavy areas may not be completely dry when the rest of the load has reached the selected dryness level. This is normal. Select the "MORE DRY" setting if desired.
- If one heavy item is dried with a lightweight load, such as one towel with sheets, it is possible that the heavy item will not be completely dry when the rest of the load has reached the selected dryness level. Sort heavy items from lightweight items for best drying results.

### HAS AN ODOR

- Household odors such as from painting, varnishing, strong cleaners, etc. may enter the dryer with the surrounding room air. This is normal as the dryer draws the air from the room, heats it, pulls it through the tumbler and exhausts it to the outside. When these odors are present in the air, ventilate the room completely before using the dryer.

For further assistance contact

Maytag Appliances Sales Company, Maytag Customer Assistance:

U.S. 1-800-688-9900 or Canada 1-800-688-2002

U.S. customers using TTY for deaf, hearing impaired or speech impaired,  
call 1-800-688-2080.

# CLOTHES DRYER WARRANTY

## Full One Year Warranty

For one (1) year from the date of original retail purchase, any part which fails in normal home use will be repaired or replaced free of charge.

## Limited Warranty

After the first year from date of original retail purchase, through the time periods listed below, the parts designated below which fail in normal home use will be repaired or replaced free of charge for the part itself, with the owner paying all other costs, including labor, mileage and transportation.

**Second Year** – All parts.

**Third through Fifth Year** – Dryer tumbler.

## Additional Limited Warranty Against Rust-Through

Should an exterior cabinet, including the door, rust through during the one year period starting from the date of retail purchase, repair or replacement will be made free of charge. After the first and through the tenth year, repair or replacement will be made free of charge for the part itself, with the owner paying all other costs, including labor, mileage and transportation.

**Please Note:** This full warranty and the limited warranty apply when the dryer is located in the United States or Canada. Dryers located elsewhere are covered by the limited warranty only, including parts which fail during the first two years.

## Canadian Residents

This warranty covers only those dryers installed in Canada that have been listed with the Canadian Standards Association unless the dryers are brought into Canada due to transfer of residence from the United States to Canada.

The specific warranties expressed above are the **ONLY** warranties provided by the manufacturer. This warranty gives you specific legal rights, and you may also have other rights that vary from state to state.

## TO RECEIVE WARRANTY SERVICE

To locate an authorized service company in your area contact the Maytag dealer from whom your appliance was purchased; or call Maytag Appliances Sales Company, Maytag Customer Assistance at the number listed below. Should you not receive satisfactory warranty service, please call or write:

Maytag Appliances Sales Company

Attn: CAIR® Center

P.O. Box 2370

Cleveland, TN 37320-2370

**U.S. 1-800-688-9900**

**Canada 1-800-688-2002**

**U.S. customers using TTY for deaf, hearing impaired or speech impaired, call 1-800-688-2080.**

When contacting Maytag Appliances Sales Company, Maytag Customer Assistance about a service problem, please include the following:

- a. Your name, address and telephone number;
- b. Model number and serial number (found on the lower center of the door opening) of your appliance;
- c. Name and address of your dealer and the date the appliance was purchased;
- d. A clear description of the problem you are having.
- e. Proof of purchase.

## WHAT IS NOT COVERED BY THESE WARRANTIES:

1. Conditions and damages resulting from any of the following:
  - a. Improper installation, delivery, or maintenance.
  - b. Any repair, modification, alteration or adjustment not authorized by the manufacturer or an authorized servicer.
  - c. Misuse, abuse, accidents, or unreasonable use.
  - d. Incorrect electric current, voltage or supply.
  - e. Improper setting of any control.
2. Warranties are void if the original serial numbers have been removed, altered, or cannot be readily determined.
3. Light bulb.
4. Products purchased for commercial or industrial use.
5. The cost of service or service call to:
  - a. Correct installation errors.
  - b. Instruct the user on proper use of the product.
  - c. Transport the appliance to the servicer.
6. Consequential or incidental damages sustained by any person as a result of any breach of these warranties.

Some states do not allow the exclusion or limitation of consequential or incidental damages, so the above exclusion may not apply.

User's Guides, service manuals and parts catalogs are available from Maytag Appliances Sales Company, Maytag Customer Assistance.